

OHMED

Instructions for Use

 **vertica**

Product model: OH_Prod0001/2



ATTENTION!

The Vertica® device is designed for personal and intimate medical treatment at home. The device left our factory clean and ready for use. The device will be considered as “used” after removing or damaging the tamper-evident seal on the device.

These are the original English instructions.

March 2024 | OH_Misc0008_RevF

CONTENTS

1	Preface	4
1.1	Important Notes	4
1.2	Description of the user	4
1.3	Intended use and reasonably foreseeable misuse	4
1.3.1	Intended use	4
1.3.2	Reasonably foreseeable misuse	5
1.4	Conventions used in this manual	5
2	About the Vertica treatment process	6
2.1	About erectile dysfunction	6
2.2	Working principle of the Vertica device	6
2.3	Overview of the treatment process	8
2.4	Possible side effects	9
2.5	What to expect after the treatment?	10
3	Description of the Vertica device	11
3.1	Contents of the packaging	11
3.2	Product elements	12
3.2.1	The Vertica device and pad	12
3.2.2	The control panel	13
3.3	Technical data	14
3.4	Consumables	15
3.5	Safety features	15
3.6	Explanation of symbols on the packaging and the device	16
3.7	Rating label	18
4	Contraindications	19
5	Safety instructions	20

6	Learning the basic operation of the Vertica device	23
6.1	Charging the Vertica device	23
6.2	Setting the device to on and off	25
6.3	Setting the energy level	25
6.4	Activating and deactivating the treatment mode	26
6.4.1	Activating the treatment mode by pushing the energy button	27
6.4.2	Activating and locking the treatment mode	28
7	Let's get started with the treatment!	29
7.1	Preparation	30
7.2	Treatment	30
7.2.1	First part of the treatment (RING mode)	31
7.2.2	Second part of the treatment (RING+PAD mode)	36
8	Cleaning the Vertica device	40
9	Storing the Vertica device	43
10	Troubleshooting	44
11	Disposal	47
12	Warranty	48
12.1	Warranty	48
12.2	Service under warranty	48
12.3	Limitation of liability	48
13	Declarations	49
13.1	Electromagnetic emissions	49
13.2	Electromagnetic immunity	50
13.3	Test specifications for ENCLOSURE PORT IMMUNITY to RF wireless communications equipment	53

1 PREFACE

1.1 IMPORTANT NOTES

Congratulations on your new Vertica® device. For your safety and the success of treatments:

- Read and understand this entire user manual before using your Vertica device.
- Keep the *Instructions for Use* and *Quick Start Guide* for future reference.
- Pay special attention to the instructions, warnings, precautions, and safety instructions.

1.2 DESCRIPTION OF THE USER

- This document is intended for the home user of the Vertica device.
- The Vertica device is intended for adults only.

1.3 INTENDED USE AND REASONABLY FORESEEABLE MISUSE

1.3.1 INTENDED USE

- The Vertica device is designed for personal and intimate use for the medical treatment of erectile dysfunction (ED) to improve the erectile function and to increase cavernosal volume.
- The Vertica device is non-invasive, battery-powered, and intended for home use in a private setting.
- The Vertica device is only intended for use by adults and on adults.
- The Vertica device is only intended for use on humans.
- The Vertica device shall be used with original parts and accessories.

1.3.2 REASONABLY FORESEEABLE MISUSE

The Vertica device shall only be used in accordance with the instructions described in this manual. Any use other than those described in this user manual is considered as non-intended use. This will also invalidate the warranty.

1.4 CONVENTIONS USED IN THIS MANUAL

- The Vertica device is also referenced as 'device', 'Vertica', or 'product'.
- Gel refers to water-based ultrasound gel or water-based RF conductive gel.
- **Bold** indicates product elements.
- *Italic* indicates sections or publication titles referenced in the text.



This symbol indicates possible safety risks.



This symbol indicates information and tips.

2 ABOUT THE VERTICA TREATMENT PROCESS

2.1 ABOUT ERECTILE DYSFUNCTION

An erection is a neuro-vascular event, which means it involves both the nerves (nervous system) and the blood vessels (vascular system).

Excited nerves initiate an erection by dilating the blood vessels that are used for the blood flow into the penis. This results in increased blood flow. When the nervous system and vascular system are intact, an erection occurs. Any neural or vascular dysfunction may have a negative effect on normal erectile function.

2.2 WORKING PRINCIPLE OF THE VERTICA DEVICE

Powered by patented technology, Vertica is the first device that targets the blood vessels involved in erectile function by using radio frequency energy (RF energy). The RF energy heats the areas involved in the erectile process and this widens the blood vessels (vasodilation) and allows more blood inflow.

The Vertica device has two main parts that accurately give a deep treatment for erectile dysfunction:

- The **ring**, for treatment of the erectile tissue in the visible part of the penis (the penis shaft).
- The **pad**, for treatment of the erectile tissue that is located deep in the pelvis and behind the pubis (through the perineum).

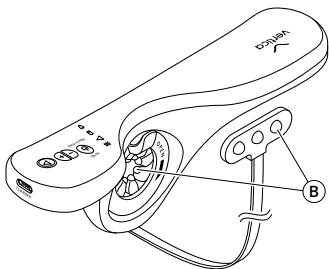

*The RF electrodes **B**, on the ring of the Vertica device and the pad*

The ring and the pad have radio frequency generator electrodes (RF electrodes) and one pair of pins that supply the RF energy to the treatment area. The RF electrodes are located around the inner circle of the ring, and on the pad for an optimal treatment.

The ring and the pad allow for treatment of the full length of the erectile tissue and provide a complete therapeutic treatment for erectile dysfunction.

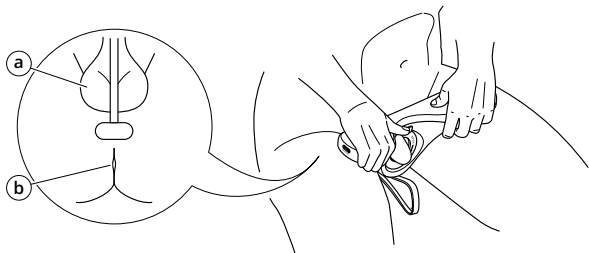

*Placement of the pad in between the scrotum **a** and the anus **b**.*

During the treatment, the advanced algorithm of the Vertica device collects data to

- learn and retain calculated skin parameters
- regulate the RF energy for an equal supply to each area of treatment
- regulate the optimal energy outflow by continuously measuring the skin temperature

This process makes sure that the user experiences optimal individual results in a safe way.

2.3 OVERVIEW OF THE TREATMENT PROCESS

The treatment with the Vertica device is divided into two parts and takes place while sitting down.

During the first part of the treatment, the penile shaft is placed inside the ring of the Vertica device. Step by step the Vertica device is moved along the penile shaft to apply RF energy.

In the second part of the treatment, the pad is connected to the Vertica device and placed on the perineum (the area between the scrotum and the anus). The penile shaft is placed inside the ring of the Vertica device and the treatment is repeated. In this step, RF energy is applied through the ring and the pad. The treatment is applied to the full length of the erectile tissue.

Water-based ultrasound gel or water-based RF conductive gel is used on the penile shaft during the treatment for the best-possible energy delivery between the RF electrodes and the treatment area.

2.4 POSSIBLE SIDE EFFECTS



- **WARNING!** Discontinue the treatment if any side effect continues for more than 24 hours and consult with your doctor.
- If you have any concerns regarding sensitivity or side effects, please consult your doctor.

Possible side effects:

- Redness of the skin and minor swelling. *



The treatment is heat-based and the skin's redness and minor swelling indicate that the correct heat is applied to achieve the desired results. After the treatment, the redness of the skin and minor swelling will subside.

- Mild local pain, blistering, stinging, burning, or flaking.



These effects can last several minutes and are expected to become less over time with subsequent treatments.

* RF energy output will automatically stop when the sensors detect a lack of RF gel or contact with the penis.

2.5 WHAT TO EXPECT AFTER THE TREATMENT?



Treatment results are different for each user due to individual uniqueness. The manufacturer does not guarantee results.

Short-term Effect (Immediately after treatment)

After a treatment session, an overall warm sensation is felt on the treated area. This effect subsequently dissipates.

Long-term Effect

A gradual improvement in erectile function is expected.

3 DESCRIPTION OF THE VERTICA DEVICE

3.1 CONTENTS OF THE PACKAGING

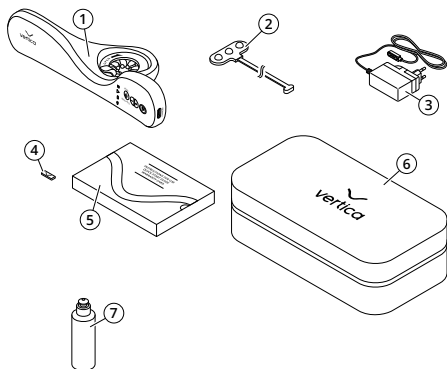

ID	Name	ID	Name
1	Vertica device	5	Instructions for Use, Quick Start Guide and Device Warranty Card
2	Pad	6	Storage box
3	Charger	7	Ultrasound or RF conductive gel (with CE certification *)
4	Charging port cap		



* Due to customs regulations the ultrasound or RF conductive gel is not always part of the delivery. Any water-based gel intended for ultrasound or RF conduction is suitable for use with the Vertica device and can be bought separately through stores in your country or on the Vertica website.

3.2 PRODUCT ELEMENTS

3.2.1 THE VERTICA DEVICE AND PAD

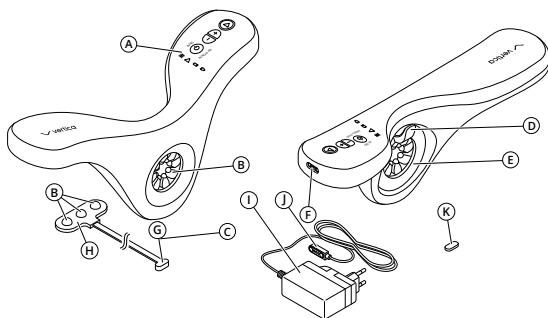

ID	Name	ID	Name
A	Control panel	G	Pad plug (magnetic)
B	RF electrodes (metal domes)	H	Pad
C	Pad port (magnetic)	I	Charger
D	Ring handle	J	Charger plug (magnetic)
E	Ring	K	Charging port cap
F	Charging port (magnetic)		

3.2.2 THE CONTROL PANEL

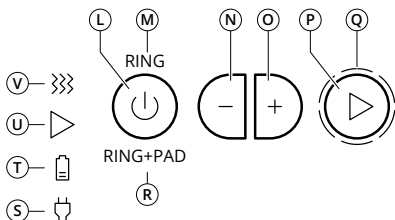

ID		Function
L	Power/treatment mode button	To set the device to on or off and select the RING mode or RING+PAD mode
M	RING mode indicator	To indicate the RING mode is selected
N	Energy level button (-)	To decrease the energy level
O	Energy level button (+)	To increase the energy level
P	Energy button	To activate and deactivate the treatment mode
Q	Energy level indicator	To indicate the energy level (1 to 6)
R	RING+PAD mode indicator	To indicate the RING+PAD mode is selected
S	Charging cable indicator	To indicate the charging cable is connected to the power port
T	Battery indicator	To indicate charging is in progress and the battery status
U	Treatment indicator	To indicate the treatment is active
V	RF energy indicator	To indicate the delivery of RF energy

3.3 TECHNICAL DATA

Parameter	Value
Device name	Vertica
Designation	Treatment device for erectile dysfunction
Type	Class IIA
Internal rechargeable battery (not replaceable)	Li-ion, 1500 mAh
Input power	AC 100 V to 220 V, 50 to 60Hz, 0.5 A
Output power	DC 15 V, 0.8 A
Energy consumption	12 W
Dimensions (excluding accessories) Height x Width x Depth	55 mm x 350 mm x 250 mm
Weight	170 gram
RF output frequency	1 MHz
Maximum electrode temperature	42°C ± 1°C
Maximum treatment time per mode	15 minutes of RF energy delivery
Transport and storage conditions	Temperature: -25°C to +60°C
	Relative humidity: maximum 95% at +40°C
	Atmospheric pressure: maximum 1100 hPa
Operating conditions	Temperature: +15°C to +30°C
	Relative humidity: maximum 60%
	Atmospheric pressure: maximum 1100 hPa
IP rating	IP22

3.4 CONSUMABLES

During the treatment, water-based ultrasound gel or water-based RF conductive gel is used on the penile shaft for the best-possible energy delivery between the RF electrodes and the treatment area.



Any water-based gel intended for ultrasound or RF conduction is suitable for use with the Vertica device and can be bought separately or on the Vertica website. Do not use any other type of gel.





3.5 SAFETY FEATURES











With Vertica, your safety comes first! The Vertica device is designed with the following safety features:

Safety feature	Function
Prevention for overheating of the treatment area	<ul style="list-style-type: none"> The “smart” sensor on the device detects optimal temperature, allowing full regulation of the energy delivery. Six temperature sensors continuously monitor the skin surface temperature. The sensors are concealed inside the RF electrodes.
Penile shaft sensor	The device will not deliver RF energy when it does not sense the required penile shaft characteristics (impedance values). The RF energy indicator does not come on in this case.

Contact sensors	The device automatically stops delivering RF energy when it does not identify sufficient contact between the RF electrodes and the skin of the penis and/or the RF conductive gel. The RF energy indicator is off in this case.
Charging cable sensor	The device automatically stops all functions when the charger plug is connected to the device and the charger is connected to the power outlet.
Automatic power off	The device is automatically set to off after ten minutes of inactivity.
Automatic treatment indicator off	The device is automatically set to standby mode after minute of inactivity of RF energy delivery..

3.6 EXPLANATION OF SYMBOLS ON THE PACKAGING AND THE DEVICE

Symbol	Explanation
	Refer to the manual
	Type BF applied part
	Fragile; handle with care
	Double insulated appliance - Class 2

	Temperature limitation
	Humidity limitation
	Atmospheric pressure limitation
	Protected against solid foreign objects of 12.5 mm (0.5 in) diameter and greater; Protected against vertically falling water drops when enclosure tilted up to 15°.
	<p>This product is not to be disposed of with any other household materials in the E.U. Recycle and promote the reuse of sustainable resources in order to avoid possible harm to human health and the environment from uncontrolled waste materials.</p> <p>Use our return and collect service for used devices or simply contact the place of purchase.</p>
	Medical device manufacturer
	Authorized representative
	Date of manufacturer
	Lot number
	Medical device
	CE marking and notified body number

3.7 RATING LABEL

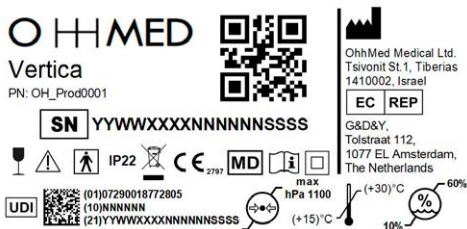

UDI QR Code description

ID	Explanation
01	UDI DI (Unique device identification)
10	Work order
21	SN (Serial number)

4 CONTRAINDICATIONS



Please consult your doctor if you have any concerns regarding medications or health conditions not listed.

Do not use the Vertica device if any of the following conditions apply to your situation:

- A cardiac pacemaker implant or suffering from any other form of heart condition e.g. Arrhythmia
- Any metallic implanted devices, including body piercings located around the area of treatment.
- Any type of skin damage to the area of intended treatment e.g. lesions
- A blood clot disorder
- Taking antiplatelet medication
- Taking or have taken Isotretinoin (Accutane) in the last 12 months
- Any neurostimulator implant

5 SAFETY INSTRUCTIONS



WARNING! Read and understand this user manual and its safety instructions before using this device. Failure to observe the safety instructions can result in physical injury, damage, or harm to the environment. The manufacturer accepts no liability for injury or damage resulting from failure to observe the safety instructions.

- **RISK OF INJURY!** Only use this device for its intended function and as instructed in this user manual.
- **RISK OF INJURY!** Do not use this device if you have any of the conditions mentioned in *4 Contraindications*.
- **RISK OF INJURY!** This electrical device uses radio frequency wavelengths. The use of energy emitting devices for example, laser, intense pulse light, and radio frequency (RF), shall be in accordance with the instructions in the user guidelines. When the device is used in a manner not intended, serious injury may occur.
- This equipment/system may cause radio interference or may disrupt the operation of nearby equipment. It may be necessary to take mitigation measures, such as re-orienting or relocating the Vertica device or shielding the location.
- Always set the device to off after each treatment session and during cleaning procedures.
- Only use the supplied charger to charge the device. Do not use any other charger!
- Do not use the device if it is damaged.

- Do not operate the device close to any flammable liquids (i.e. alcohol and acetone).
- Always keep the device out of reach of children.
- Do not use the device on any other parts of the body other than those permitted in the instructions.
- Only use water-based RF conductive gel or water-based ultrasound gel with the device and make sure the gel meets the regulatory requirements of the local Ministry of Health. Do not use any other type of gel.
- After using the device, wait at least five minutes before having sexual intercourse. This time is necessary for the urethral tissue to cool down to less than 41°C.
- For your safety and in order to achieve effective treatment:
 - Always apply a generous layer of gel, according to the instructions.
 - Add gel as needed during the treatment.
 - Do a check of the validity and expiry dates on the label of the RF conductive gel/ultrasound gel.
 - After opening, the RF conductive gel/ultrasound gel can be used for 12 months. Do not use the gel past these 12 months.
- The device is fully factory assembled. Do not attempt to open, puncture, break or repair the device in any way.
- Clean the RF electrodes, the device and the accessories after each use according to the instructions of the manufacturer.
- When the device is not in use, store the device and accessories, in the original storage box, in a dry and safe place, away from the reach of children, direct sun-light and heat.

- Always store the device and accessories in the original storage box for transport to prevent damage.
- Keep the device and the charger away from dampness, or debris that may collect between the RF electrodes, on the plugs or ports of the device and accessories.
- **RISK OF INJURY!** Do not burn or puncture the battery. The device contains a rechargeable battery (Lithium-Ion (Li-Ion)). If burnt or punctured, it may release toxic materials causing injury. The internal, rechargeable battery is not replaceable.
- Do not exceed the allowable ambient temperatures during charging, operating, or storage. The life of Li-Ion batteries is strongly influenced by their care. If properly maintained, the battery is capable of more than 300 charge/discharge cycles before dropping to 80% of the capacity.
- **RISK OF INJURY!** No modification of this equipment is allowed. Do not modify this equipment without authorization from the manufacturer. If this equipment is modified, appropriate inspection and testing must be conducted to ensure continued safe use of the equipment.
- Disposal of the Vertica device must be in accordance with EC regulations and regulations in the country of purchase. For more information on how to safely dispose of your device, please contact customer service or otherwise visit your local recycling center.
- If any serious incident takes place with the device, please report this to customer service.
- If a serious incident takes place with the device, you may report it to the regulatory authorities of your country.











6 LEARNING THE BASIC OPERATION OF THE VERTICA DEVICE

6.1 CHARGING THE VERTICA DEVICE



- Fully charge the device before you use it for the first time.
- After every use, charge the device for a minimum of five hours.
- Treatment is not possible when the charger is connected to the power outlet and the magnetic charger plug is connected to the charging port.

The **battery indicator** and **charging cable indicator** show the following conditions during operation:

Indicator	Lighting	Meaning	
		Charging off Battery off	Charging cable is not connected.
		Charging on Battery on	Charging cable is connected. Battery is charging.
		Charging on Battery off	Charging cable is connected. Battery is fully charged.
		Charging off Battery flashing	Charging cable is not connected. Low battery.
		Charging on Battery flashing	Charging cable is connected. Battery or charger may have an error. See <i>Troubleshooting</i> .

To charge the device:

1. Make sure the **charger** is disconnected from the power outlet.
2. Connect the magnetic **charger plug** to the **charging port**. The charging cable indicator comes on.

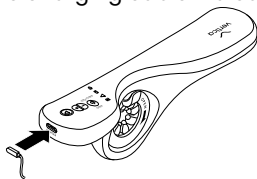

3. Connect the **charger** to the power outlet. The battery indicator comes on and the battery charges.

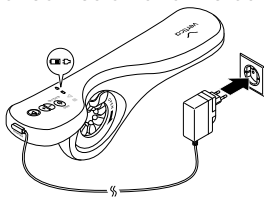

4. Let the device charge for a minimum of five hours or until the **battery indicator** is off.



When the battery is fully charged, the **battery indicator** is off. If the battery indicator flashes during the charging, disconnect the charger from the power outlet and disconnect the charger plug from the device. See *Troubleshooting* for more information.

5. Disconnect the **charger** from the power outlet
6. Disconnect the magnetic **charger plug** from the **charging port**. The charging cable indicator is off.

6.2 SETTING THE DEVICE TO ON AND OFF

To set the device to on:

- Push the **power/treatment mode button**.
The RING mode indicator and energy level indicator come on. The device is on and in standby mode.

To set the device to off:

- Push and hold the **power/ treatment mode button** for 3 seconds.
The device vibrates for a short moment and all indicator lights are off. The device is off.

6.3 SETTING THE ENERGY LEVEL



Each time the device is set to on, the energy level is automatically set to energy level one.







The energy level of the treatment can be set, at any time, to six different levels with the **energy level buttons (+/-)**. Energy level one is the minimum and energy level six is the maximum level.

To set the energy level:

1. Push the **energy level button (+)** to increase the energy level.
Each time you push the button, the energy increases by one level. The energy level indicator shows the set energy level.

2. Push the **energy level button (-)** to decrease the energy level.
Each time you push the button, the energy decreases by one level. The energy level indicator shows the set energy level.

The energy level indicator shows the following conditions, based on the set energy level:

Energy level indicator						
Energy level	1 (minimum)	2	3	4	5	6 (maximum)

The energy level indicator lights up continuously. When the treatment button is locked the energy level indicator flashes during treatment (see *Activating and deactivating the treatment mode*).

6.4 ACTIVATING AND DEACTIVATING THE TREATMENT MODE



WARNING!

Activating the treatment mode only *prepares* the device for the treatment.

The actual treatment with RF energy is indicated by the **RF energy indicator!**

What happens in the treatment mode:



1. The device automatically checks for contact with the penile shaft.
2. Only when contact with the penile shaft is detected, the **RF energy indicator** comes on and RF energy is delivered (the erectile tissue is receiving treatment).

NOTICE The treatment is only in progress when the RF energy indicator is on. There is no treatment when the RF energy indicator is off.

The treatment mode can be activated in two ways:

- Push and hold the energy button continuously
- Locking the treatment mode

6.4.1 ACTIVATING THE TREATMENT MODE BY PUSHING THE ENERGY BUTTON

To activate the treatment mode:

1. Make sure the device is set to on, the treatment mode indicator is on and the energy level indicator is on.
2. Push and hold the **energy button**.

The treatment indicator flashes, the energy level indicator flashes and the treatment mode indicator is on.

To deactivate the treatment mode:

- Release the **energy button**.

The treatment mode indicator is off and the device is in standby mode.

6.4.2 LOCKING THE ENERGY BUTTON

When you lock the energy, you can release the energy button and the treatment remains active.

To activate the locking function:

1. Make sure the device is set to on.
2. Push and hold the **energy button** continuously for a minimum of 5 seconds.
3. Push the **energy button** two times to lock the energy delivery.

The treatment indicator changes from flashing to continuous.

To unlock and deactivate the treatment mode:

1. Push any button on the device to unlock the energy button.

The device will enter stand by mode. The treatment mode indicator and the RF energy indicator are off.

7 LET'S GET STARTED WITH THE TREATMENT!

WARNING!

- Make sure you have read the safety instructions.
- Make sure the Vertica device is fully charged. See *Charging the Vertica device* for instructions.
- Do not do the treatment while standing. Make sure you are in a comfortable seated position to do the treatment.
- When the treatment is set to on:
 - always move the device toward the glans (dome of the penis) and not toward the body.
 - all RF electrodes should be continuously in contact with the skin.
- Make sure the charging cable is not connected to the Vertica device.
- Always make sure there is sufficient gel on the penile shaft during the treatment and add gel when needed.
- You may feel a warm sensation on the skin during the treatment, this may indicate to add more gel.
- Lower the energy level with the energy level button (-) if the temperature sensation is uncomfortable.
- If you do not experience any heat during treatment, see *Troubleshooting* for more information.



7.1 PREPARATION

It is recommended to

- make sure you are in a comfortable seated position, for example on a chair or the edge of the bed
- make sure you have enough gel for the full treatment
- make sure you have a towel to wipe the gel off your hands
- shave the perineal area (the area between the anus and scrotum), before applying the **pad**.

7.2 TREATMENT

The full treatment with the Vertica device is divided into two parts:

- Treatment of the penile shaft in the RING mode, duration 15 minutes of RF energy delivery.
- Treatment of the penile shaft and the perineum area in the RING+PAD mode, duration 15 minutes of RF energy delivery.

- **15 minutes of RF energy delivery**



During the treatments, the Vertica device counts the time of each RF energy delivery (the time that the RF energy indicator is on). The Vertica device will vibrate when the sum of the times is at 15 minutes to indicate the end of the treatment.

- **Recommended treatment schedule**

During the first month of treatment, do the full treatment three times per week. During the second month of treatment, do the full treatment at least two times per week. From the third month and onwards, do the full treatment at least one time per week.

7.2.1 FIRST PART OF THE TREATMENT (RING MODE)

1. Apply a three to five millimeter thick layer of gel (ultrasound or RF conductive gel) on the penis shaft. Make sure to cover the full surface of the penis shaft.



To achieve optimal treatment, the domes of the RF electrodes on the ring need to be covered by the gel. Add gel during the treatment when needed.

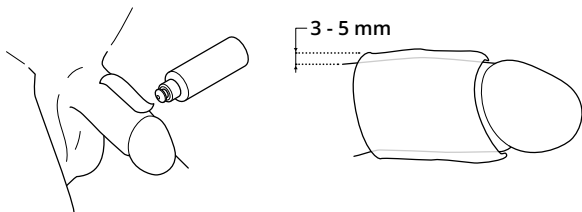

2. Push the **power/treatment mode button** to set the device to on.
The device is in standby mode. The RING mode indicator comes on and the energy level indicator shows energy level one.
3. Make sure you hold the Vertica device with the control panel on the right-hand side.

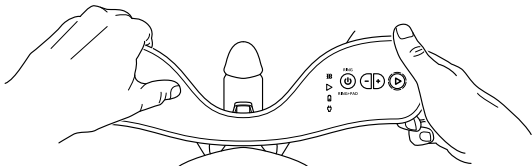

4. Push the **ring handle** to the left to open the **ring** and insert the penis through the **ring**. Slide the Vertica device as close to the body as possible.



The device should make contact with your pelvic area.

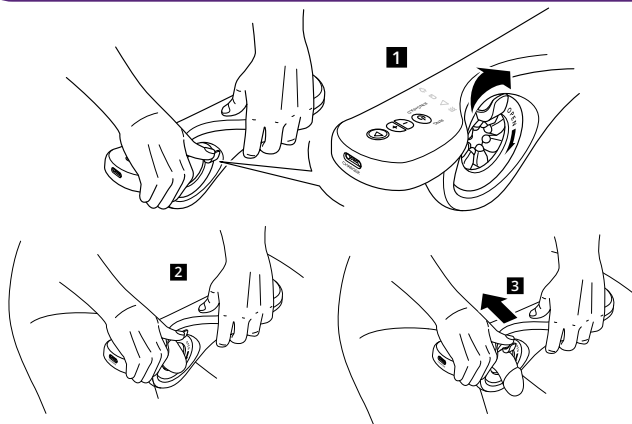

5. Gently release the **ring handle** to let the **ring** make comfortable and tight contact of all the RF electrodes with the penile shaft.

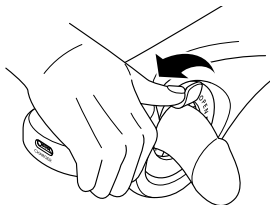

- Select the desired energy level with the **energy level buttons (+/-)**.

The energy level indicator shows the set energy level.



It is recommended to start every treatment at level one for at least 1 minute and increase based on the sensation of heat that you desire. You are able to increase or decrease the energy level during the treatment. Choose the energy level that you feel comfortable with during treatment. Stop the treatment if you feel pain during the treatment session.

- Push and hold the **energy button** to activate the treatment mode.

The treatment mode indicator flashes. The RF energy indicator comes on and the device delivers RF energy.



The treatment does not start when the RF electrodes are not in contact with the penile shaft. When the RF energy indicator does not come on, see *Troubleshooting*.

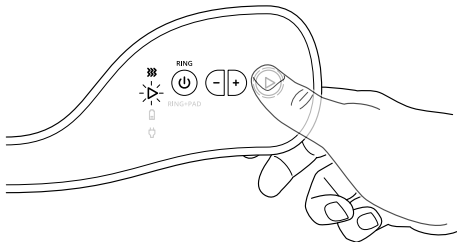

- Wait 30 seconds or wait until the **RF energy indicator** is off for at least 3 seconds and move the device about one centimeter toward the glans (dome of the penis).



Always move the device toward the glans (dome of the penis) and not toward the body. You may select the desired **energy level with the energy level buttons (+/-)**.

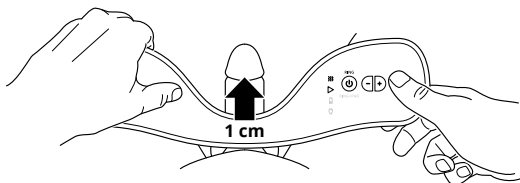

- Wait for the RF energy indicator to come on again.
- Repeat steps 9 and 10 until the device is at the glans and can not slide any further.
- When you cannot slide the device any further, release the **energy button** to deactivate the treatment mode.
- Push and hold the **ring handle** to open the **ring**. Slide the Vertica device as close to the body as possible to prepare to continue the treatment.



The device should make contact with your pelvic area.

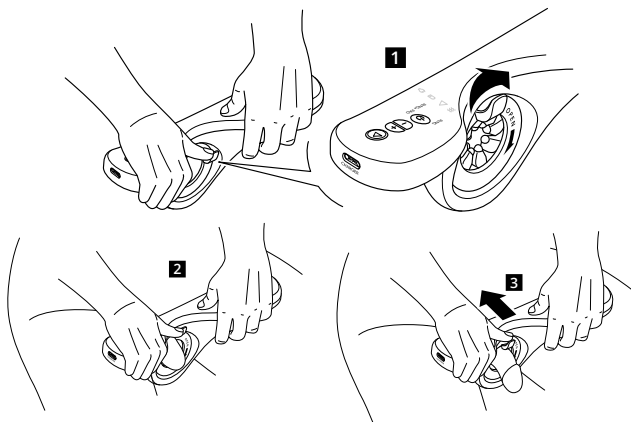

13. Gently release the **ring handle** to let the **ring** make a comfortable and tight contact with the penile shaft.

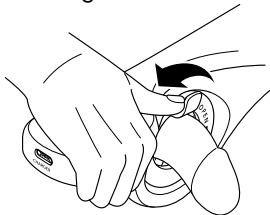

14. Repeat steps 7 to 13 until a total treatment time of 15 minutes is achieved.



The device will vibrate multiple times and the **RING mode** and **RING+PAD mode** indicators will blink to indicate the treatment is finished.

15. Push the **ring handle** to open the **ring** and slide the device off the penis.

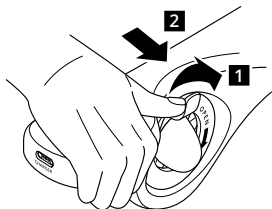

16. Press the power/treatment mode button to continue to the second part of the treatment (*RING+PAD mode*).

7.2.2 SECOND PART OF THE TREATMENT (RING+PAD MODE)

1. Apply a three to five millimeter thick layer of gel (ultrasound or RF conductive gel) on the penis shaft. Make sure to cover the full surface of the penis shaft.



To achieve optimal treatment, the domes of the RF electrodes on the ring need to be covered by the gel. Add gel during the treatment when needed.

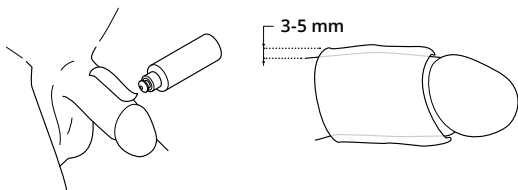

2. Connect the **pad plug** to the **pad connector**.



The magnetic pad plug attaches only in one direction. Change the position of the pad plug in if it does not connect.

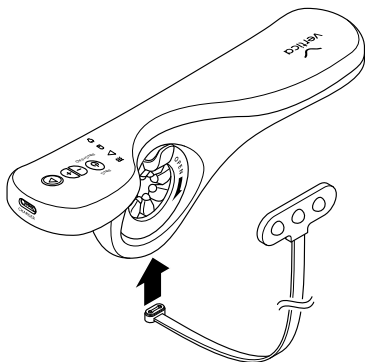

3. Curve the cable of the **pad** under the device so the RF electrodes point up. Take a seated position on a chair and place the **pad** on your perineum (the area between the **scrotum** ① and the **anus** ②).



Always make sure the pad is in contact with the perineum during the treatment.

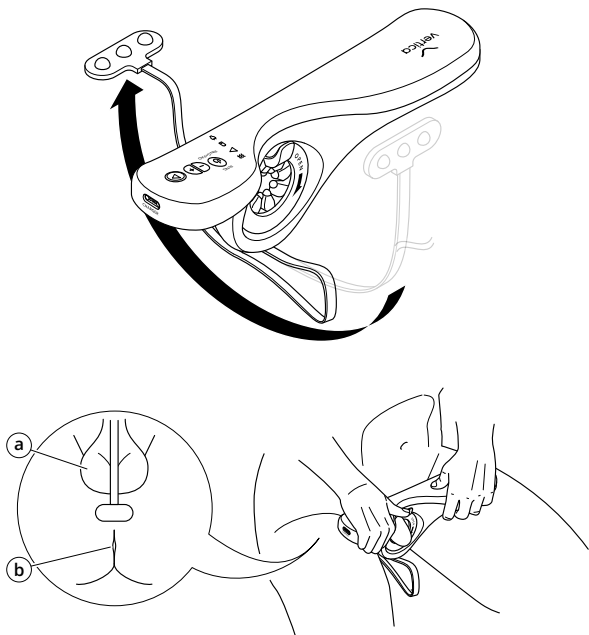

4. Make sure **RING+PAD mode** is selected:
 - a. When the device is off:
 - i. Push the **power/treatment mode button** to set the device to on.
The device is in standby mode. The RING mode indicator comes on and the energy level indicator shows energy level one.

- ii. Push the **power/ treatment mode button** to select the **RING+PAD mode**.
The RING+PAD mode indicator comes on and the RING mode is off.
 - b. When the device is on and the **RING mode indicator** is on:
 - i. Push the **power/ treatment mode button** to select the **RING+PAD mode**.
The RING+PAD mode indicator comes on and the RING mode is off.
5. Follow steps 3 to 15 of the *First part of the treatment (RING-mode)*.
6. Push the **power/ treatment mode button** for three seconds to set the device to off.



- During the second part of the treatment, RF energy is delivered through the RF electrodes of the ring and the pad.
- When the treatment is completed, continue with cleaning and charging the Vertica device.

8 CLEANING THE VERTICA DEVICE

WARNING!



- Set the device to off before you do any cleaning tasks.
- Do not immerse the device in water! Only rinse the device. The device is water-resistant at the area of the RF electrodes, but the device can not be immersed.
- Always clean the ring and pad after every use.
- Only use clean tap water.
- Be careful not to rinse with hot water to avoid burning your hands.
- Do not use any detergents, soap, alcohol or other cleaning agents.
- Do not use any abrasive cleaning materials.



Scan the QR-code to see the video of the Vertica cleaning procedure.



To clean the device and the RF electrodes:

1. Make sure that
 - a. the device is set to off
 - b. the magnetic plug of the charger is disconnected from the charging port
 - c. the pad is disconnected from the device.

2. Clean the device and the pad with a moist cloth or a water-based wet-wipe.

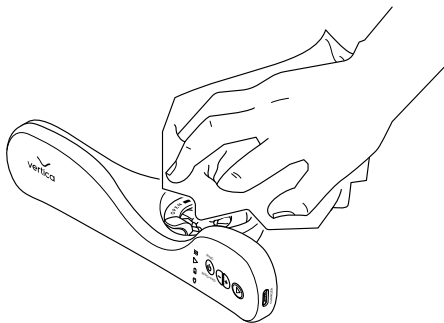

3. Flush the **RF electrodes** on the **ring** and **pad** with running tap water and fully remove all gel residue. If necessary, use warm water to dissolve the gel better.



WARNING! Do not immerse the device in water.

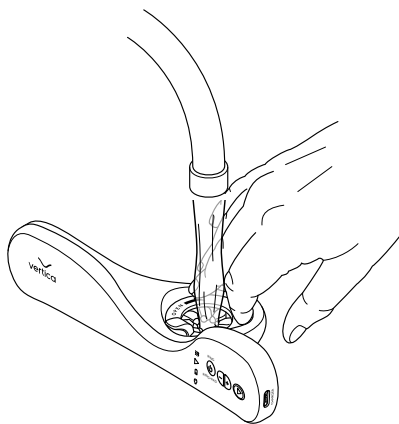

4. Make sure all gel residue is fully removed and fully dry the device and the pad with a clean dry cloth.

9 STORING THE VERTICA DEVICE

- After use, store the clean Vertica device and the accessories in the original storage box.
- Use the charging port cap to close the charging port of the Vertica device.
- Store the device at room temperature and keep it out of reach of children.
- Make sure to charge the battery fully at least one time every three months to maintain its functionality.

10 TROUBLESHOOTING

Use the information in the table to help solve any difficulty you may experience with your Vertica device.

Problem	Cause	Solution
The device does not power on	The battery is empty	Charge the device See <i>Charging the Vertica device</i>
The treatment mode indicator is on but no heat sensation is perceived	The skin of the penile shaft is not recognized by the device and the RF energy indicator does not come on	Apply sufficient gel on the penile shaft
	Not enough gel applied on the penile shaft	Apply sufficient gel on the penile shaft
The area of the treatment is not warm	Not enough gel applied on the penile shaft	Apply sufficient gel on the penile shaft
	The RF electrodes are not in contact with the skin	Make sure that all RF electrodes are in contact with the skin
	The energy level is set to level one (one LED of the energy level indicator is on)	Push the +energy level button to increase the energy level
The area of the treatment is too warm	Not enough gel applied on the penile shaft	Apply sufficient gel on the penile shaft
	The RF electrodes are not in contact with the skin	Make sure that all RF electrodes are in contact with the skin
	The energy level is set too high	Push the -energy level button to decrease the energy level

The RF energy indicator does not come on	Not enough gel applied on the penile shaft	Apply sufficient gel on the penile shaft
	The RF electrodes are not in contact with the skin	Make sure that all RF electrodes are in contact with the skin
	The treatment mode is not active	Activate the treatment mode. See <i>Activating and deactivating the treatment mode</i> .
The battery indicator flashes (while the charging cable indicator is off)	The battery power is low	Charge the device. See <i>Charging the Vertica device</i>
The battery indicator flashes (while the charging cable indicator is on)	The battery or charger may have an error	<ol style="list-style-type: none"> 1. Disconnect the charger from the power outlet 2. Disconnect the charger plug from the charging port. 3. Wait one minute. 4. Connect the charger plug to the charging port. 5. Connect the charger to the power outlet. The battery indicator comes on and should not flash. <p>NOTICE If the battery indicator continues to flash when charging, contact customer support.</p>

<p>The battery indicator does not come on during charging</p>	<p>The device is not connected correctly or not receiving power from the charger</p>	<ul style="list-style-type: none">• Make sure the charger plug of the charger is correctly connected to the charging port• Do a check of the power outlet. <p>Contact customer support if the issue can not be solved.</p>
<p>You are experiencing side effects from the treatment</p>	<p>Sensitivity to heat treatment or to the used gel</p>	<p>Contact our customer support and consult with your doctor</p>
<p>You are experiencing heat sensation to the testicles by the pad</p>	<p>Incorrect placement of the pad</p>	<p>Place the pad according to the instructions in the <i>Second part of the treatment (RING+PAD-mode)</i></p>

11 DISPOSAL

The device contains a rechargeable battery (Lithium-Ion (Li-Ion)). Like other batteries of this type, if burned or punctured, it could release toxic material which could cause injury. The device has no replaceable internal power source (batteries are not replaceable).

If you wish to dispose of the device, do not disassemble components. Discard the device entirely. Check with local solid waste officials for details concerning recycling options and proper disposal. In the United States, call toll free 1-800-8-BATTERY - visit the Battery Recycling Corporation website at <http://www.call2recycle.org/>

12 WARRANTY

12.1 WARRANTY



For local warranty and service terms, please refer to the enclosed Warranty Card.

12.2 SERVICE UNDER WARRANTY



For local warranty and service terms, please refer to the enclosed Warranty Card.

12.3 LIMITATION OF LIABILITY



Please read the included warranty card for information on the limitations of liability applicable to your region.

Any medical concerns should be addressed with a qualified medical practitioner prior to using Vertica, and should any medical concerns arise during use, such use should be immediately ceased and the consultation of a medical practitioner should be sought. Without derogating from the aforesaid, to the maximum extent permitted by law, Ohh-Med's liability is limited to only direct damages caused by its product, which liability shall not exceed the price of the product paid by the claimant.

13 DECLARATIONS

13.1 ELECTROMAGNETIC EMISSIONS

Emissions test	Compliance	Electromagnetic environment - guidance
RF emissions CISPR 11	Group 1 Class A	The Vertica uses RF energy only for its internal function. Therefore, its RF emissions are very low and are not likely to cause any interference in nearby electronic equipment.
Harmonic emissions IEC 61000-3-2	Class A	The Vertica is suitable for use in all establishments other than domestic and may be used in domestic establishments and those directly connected to the public low-voltage power supply network that supplies buildings used for domestic purposes, provided the following warning is heeded: This equipment/ system may cause radio interference or may disrupt the operation of nearby equipment. It may be necessary to take mitigation measures, such as re-orienting or relocating the Vertica device or shielding the location.
Voltage Fluctuations and Flicker IEC 61000-3-3:2013	Complies	The Vertica is suitable for use in all establishments other than domestic and may be used in domestic establishments and those directly connected to the public low-voltage power supply network that supplies buildings used for domestic purposes, provided the following warning is heeded: This equipment/ system may cause radio interference or may disrupt the operation of nearby equipment. It may be necessary to take mitigation measures, such as re-orienting or relocating the Vertica device or shielding the location.

13.2 ELECTROMAGNETIC IMMUNITY

IMMUNITY test	IEC 60601 test level	Compliance level	Electromagnetic environment guidances
Electrostatic discharge (ESD) IEC 61000-4-2	8 kV contact 2, 4, 8, 15kV air	8 kV contact 2, 4, 8, 15kV air	Floors should be wood, concrete or ceramic tile. If floors are covered with synthetic material, the relative humidity should be at least 30 %.
Electrical fast transient/ burst IEC 61000-4-4	2 kV for power supply lines 1 kV for input/output lines	2 kV for power supply lines N/A	Mains power quality should be that of a typical commercial or hospital environment
Surge IEC 61000-4-5	1 kV line(s) to line(s) 2 kV line(s) to earth 2 kV Signal input/ output) to earth	1 kV line(s) to line(s) 2 kV line(s) to earth N/A	Mains power quality should be that of a typical commercial or hospital environment
Voltage dips, short interruptions and voltage variations on power supply input lines IEC 61000-4-11	0% UT; 0.5cycle at 0°, 45°, 90°, 135°,180°, 225°, 270° and 315° 0% UT; 1cycle and 70% UT; 25/30 cycles Single phase at 0° 0% UT; 250/300 cycle	0% UT; 0.5cycle at 0°, 45°, 90°, 135°,180°, 225°, 270° and 315° 0% UT; 1cycle and 70% UT; 25/30 cycles Single phase at 0° 0% UT; 250/300 cycle	Mains power quality should be that of a typical commercial or hospital environment. If the user of the Vertica requires continued operation during power mains interruptions, it is recommended that the Vertica be powered from an uninterruptible power supply or a battery.

IMMUNITY test	IEC 60601 test level	Compliance level	Electromagnetic environment guidances
Power frequency (50/60 Hz) magnetic field IEC 61000-4-8	30 (A/m)	30 (A/m)	Power frequency magnetic fields should be at levels characteristic of a typical location in a typical commercial or hospital environment.
Conducted RF IEC 61000-4-6 Radiated RF IEC 61000-4-3	3V, 6V 3V/m 3V from 0.15 to 80MHz; 6V from 0.15 to 80MHz and 80% AM at 1kHz 3V/m from 80MHz to 2.7GHz	3Vrms, 6V 3V/m 3V from 0.15 to 80MHz; 6V from 0.15 to 80MHz and 80% AM at 1kHz 3V/m from 80MHz to 2.7GHz	<p>Portable and mobile RF communications equipment should be used no closer to any part of the Vertica, including cables, other than the recommended separation distance calculated from the equation applicable to the frequency of the transmitter.</p> <p>Recommended separation distance</p> $d = \left[\frac{3,5}{V_1} \right] \sqrt{P}$ $d = \left[\frac{12}{V_2} \right] \sqrt{P}$ $d = \left[\frac{12}{E_1} \right] \sqrt{P} \quad 80 \text{ MHz to } 800 \text{ MHz}$ $d = \left[\frac{23}{E_1} \right] \sqrt{P} \quad 800 \text{ MHz to } 2,5 \text{ GHz}$

IMMUNITY test	IEC 60601 test level	Compliance level	Electromagnetic environment guidances
			<p>Where P is the maximum output power rating of the transmitter in watts (W) according to the transmitter manufacturer and d is the recommended separation distance in meters (m).</p> <p>Field strengths from fixed RF transmitters, as determined by an electromagnetic site survey, should be less than the compliance level in each frequency range.</p> <p>D Interference may occur in the vicinity of equipment marked with the following symbol:</p> 

13.3 TEST SPECIFICATIONS FOR ENCLOSURE PORT IMMUNITY TO RF WIRELESS COMMUNICATIONS EQUIPMENT

Test frequency (MHz)	Band ^{a)} (MHz)	Service ^{a)}	Modulation ^{b)}	Maximum power (W)	Distance (m)	IMMUNITY TEST LEVEL (V/m)	Compliance level (V/m)
385	380 – 390	TETRA 400	Pulse modulation ^{b)} 18 Hz	1.8	0.3	27	27
450	430 – 470	GMRS 460, FRS 460	FM ^{c)} ± 5 kHz deviation 1 kHz sine	2	0.3	28	28
710	704 – 787	LTE Band 13, 17	Pulse modulation ^{b)} 217 Hz	0.2	0.3	9	9
745							
780							
810	800 – 960	GSM 800/900, TETRA 800, iDEN 820, CDMA 850, LTE Band 5	Pulse modulation ^{b)} 18 Hz	2	0.3	28	28
870							
930							
1720	1700 – 1990	GSM 1800; CDMA 1900; GSM 1900; DECT; LTE Band 1, 3, 4, 25; UMTS	Pulse modulation ^{b)} 217 Hz	2	0.3	28	28
1845							
1970							
2450	2400 – 2570	Bluetooth, WLAN, 802.11 b/g/n, RFID 2450, LTE Band 7	Pulse modulation ^{b)} 217 Hz	2	0.3	28	28
5240	5100 – 5800	WLAN 802.11 a/n	Pulse modulation ^{b)} 217 Hz	0.2	0.3	9	9
5500							
7585							

MANUFACTURER

Ohh-Med Medical® Ltd.

Tsivonit St. 1, P.O. Box 89 Tiberias 1410002, Israel

Tel: +972-4-9036999

Email: service@vertica-labs.com

Web site: www.vertica-labs.com

EU REPRESENTATIVE

G&D&Y

Tolstraat 112,

1077 EL Amsterdam,

The Netherlands

Copyright © 2024 Ohh-Med Medical® Ltd.

Vertica® is a trademark of Ohh-Med Medical® Ltd.

All rights reserved. Patented technology.

FOR MORE INFORMATION SCAN THE QR CODE



Issue Date: March 2024 | OH_Misc0008_Rev F

