

 **vertica**[®]



Quick User Guide

Thank you for choosing Vertica®!

The guide will show you step by step how to use the device conveniently and effectively.

1 GET TO KNOW THE VERTICA®

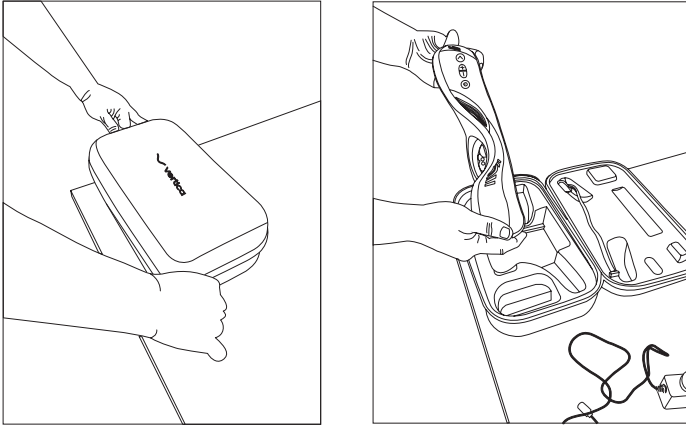

Open your Vertica® case and remove the device. Familiarize yourself with all the buttons and indicators on the Vertica® device:

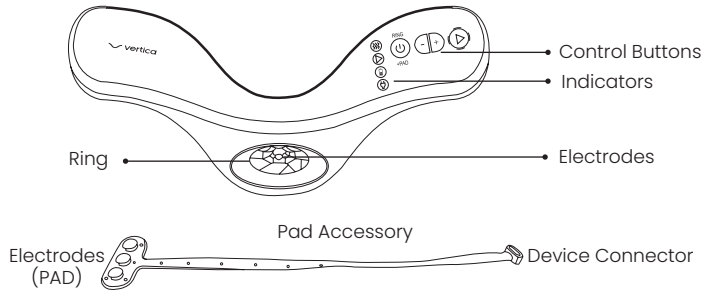

● Indicators ● Control Buttons

Energy is delivered, skin parameters are in correct range (indicated by Constant White LED)

Enabling device to power energy out (indicated by Flashing Blue LED)

Charging (indicated by Constant Orange LED)



Power Supply connected (Indicated by Constant Green LED)

Mode Indicator

Decrease Energy Level

Increase Energy Level

Power Level Indication

Energy Button – Important: It is possible to lock this function by double click x2. This feature is enable only after 5 seconds of single press. (Indicated by Constant Blue LED ). Press any button on the device to cancel lock

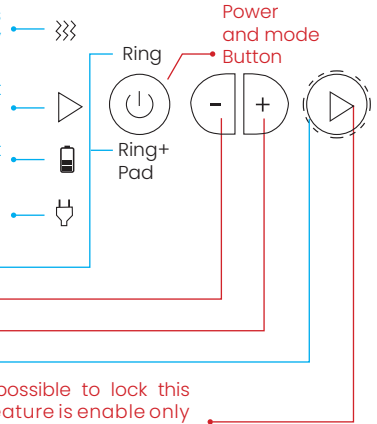

2 SIT BACK, RELAX, AND PREPARE YOURSELF FOR TREATMENT

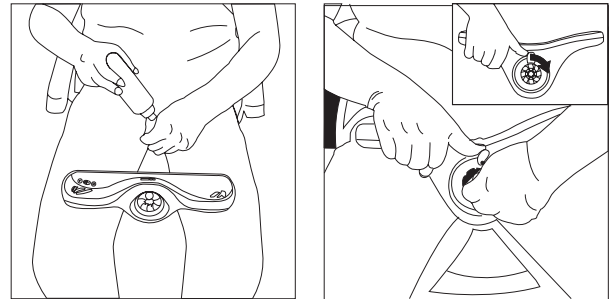

- Sit in a comfortable and quiet place. Apply the Vertica® gel or ultrasound/ RF conductive gel along the penis to fully cover the surface.
- In order to insert the penis through the ring, open the Vertica® ring, by turning the handle clockwise. You will find the handle in the front part of the device. Insert your penis through the ring and bring the device back as close to your body as possible. Now return the handle back to let the ring comfortably grip your penis inside.

3 YOU ARE ALL SET FOR TREATMENT – LET US BEGIN!

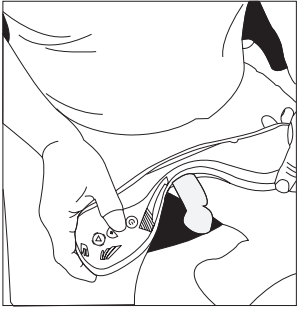

1. Press 'Power' (⊖) and assure that 'Ring' mode is on.
2. Set the energy (▷) button on the desired output level (◁▷).
3. Start with level 1 and increase to a higher level according to your desired sensation.
4. Press the 'Energy' (▷) button continuously to start treatment, blue LED ▷ will blink, followed by the white LED (⊗) light which should be ON and steady when the parameters of the skin are correct.
5. Move the device forward by about 1 cm every 30 seconds, or whenever the white (⊗) LED light is off, for at least 3 seconds continuously.
6. Whenever there is no more space to move forward, unpress the energy button before you move this stops the energy output immediately. Open the ring with the handle, take the device back to the base of the penis, and then repeat process.
7. After performing the process of 15 minutes of Energy delivery (indicated by White LED (⊗)), the device will indicate that the session has ended with 3 consecutive vibrations. Total time of treatment will depend on individual skin characteristics.
8. To resume the treatment repeat #-4.

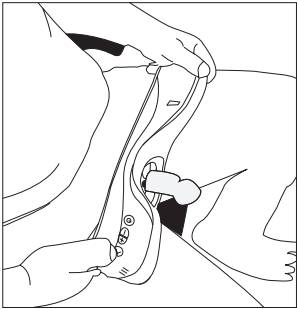

You should feel a pleasant and warm sensation.

ATTENTION:

- ▶ For continuous energy release until the treatment is completed, hold the 'Energy' button ▷ for 5 sec, then double-click it.
- ▶ Pressing any of the buttons on the device will stop the continuous energy release.
- ▶ When continuous energy release the Energy bars around the button will blink constantly and the blue led will light constantly.
- ▶ When the treatment ends, 15 min White LED, the energy output will stop with 3 consecutive vibrations.

CAUTION:

- ⚠ Do not press the energy button while moving the device throughout the penis
 - ⚠ Advance only forward with the device – not backwards.
- If you do not feel a warm sensation on the skin during the session you should either add more gel or increase the energy level.

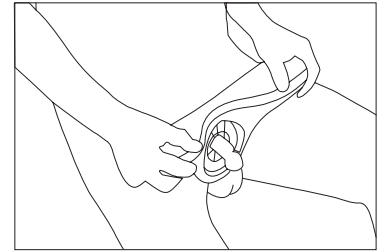

4 'RING+PAD' MODE

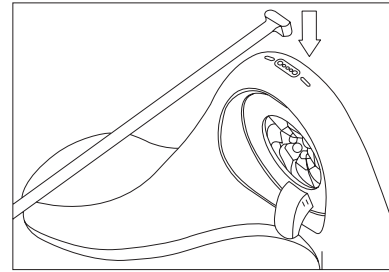

Connect the PAD extension to the device at the designated (Pad connector).

Switch the device to 'Ring + Pad' mode by pressing the 'Power' button (⊖).

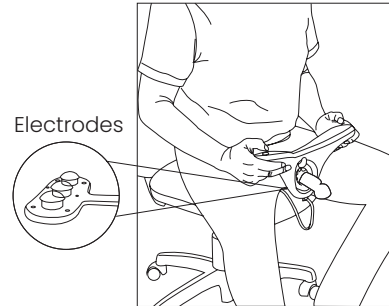

The PAD cable should be facing outward from your body.

Sit on the electrodes which are located at the end of the Pad. Make sure they are continuously touching your skin in the perineum area, between the scrotum and the rectum.

Repeat the treatment again for no less than 15 minutes according to the instructions in section 3, with the PAD accessory connected and the Pad+Ring mode is on. Be sure to move the device forward by about 1 cm every 30 seconds, or whenever the white LED light is off, for at least 3 seconds.

PAD POSITION - BOTTOM VIEW

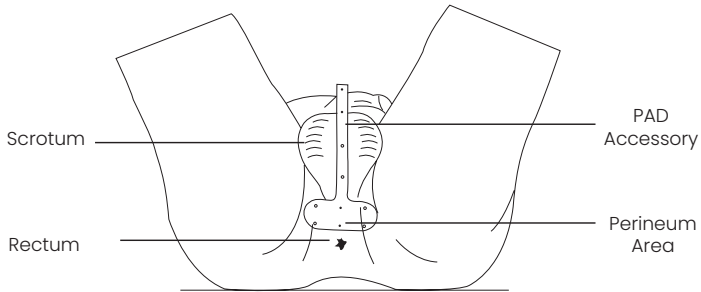

5 SWITCH OFF THE DEVICE

At the end of the treatment, switch-off the device by pressing the power button  continuously for 3 seconds.

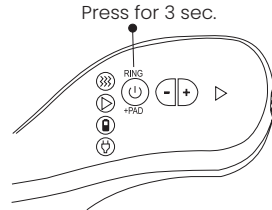

6 IT IS IMPORTANT TO CLEAN THE DEVICE AFTER THE TREATMENT

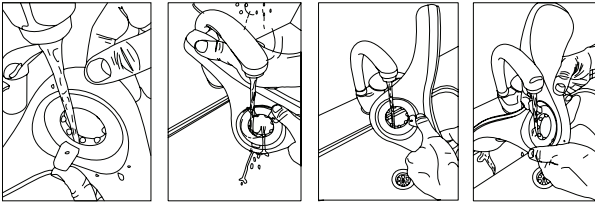

- ▶ At the end of the treatment, it is necessary to clean the pad accessory and the **ring area in the device with regular running water.**
- ▶ Open the ring area and clean between the electrodes well.
- ▶ Check to make sure that **no gel residue is present.**
- ▶ Dry the device with a clean dry cloth.
- ▶ **Failure to clean the device after use may cause the gel to accumulate in the ring mechanism and impair the proper operation of the device.**



7 CHARGE AND STORE THE DEVICE

In order to charge the device, the charging cable must be connected to the magnetic connection (Charger connector) located on the side of the device next to the control panel. Only the connect the cable to the electrical outlet.

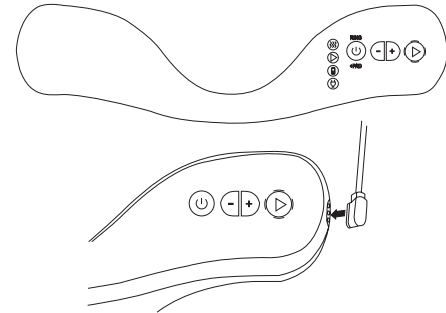

Once the device is fully charged, it is recommended to replace the device and accessories back in the case so that they are kept in a protected manner. Ensure to close the package with the zipper to prevent accessories from falling out.

