

# Vertica® User Manual

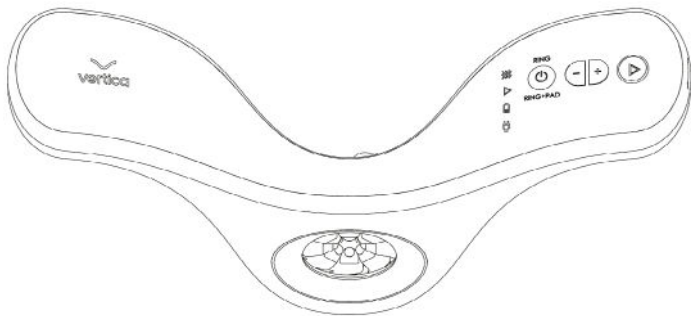

## Getting Started

Congratulations on your new Vertica® device.

For your safety and the success of treatments, please read and understand the entire user manual prior to using your Vertica® device. Keep the manual safe for future reference.

### **⚠ Your attention!**

The Vertica® device is designed for personal and intimate medical treatment at home.

The device left our factory clean and ready for use. The device will be considered as “used” after removing or damaging the tamper evident seal on the device.

## Table of contents

Important Note .....	4
Introduction .....	5
About Erectile Dysfunction (ED) .....	6
Treatment with Vertica®.....	7
Package Contents .....	8
Safety Features Information .....	8
Precaution and safety instructions .....	9
Contraindications and warnings .....	10
Possible side effects .....	10
What to Expect After Treatment?.....	11
Getting to know Your Vertica® device .....	12
Let's get started! .....	20
Recommended treatment .....	22
Recommended care .....	22
Storage instructions/conditions .....	23
Troubleshooting (FAQ) .....	24
Label Material Specifications .....	25
Care, Maintenance and Storage .....	27
Disposal of the Vertica® device .....	28
Declaration – electromagnetic emissions .....	29
Vertica® Warranty .....	33
Customer Service .....	36

## Important Note

Before you begin using your Vertica® device, it is important to carefully read all the necessary information provided in this manual.

Before using your Vertica® device please consult a doctor.

Pay special attention to Instructions, Warnings, Precautions, and Safety.

 **WARNING:** The use of energy emitting devices e.g. laser, intense pulse light, and radio frequency (**RF**), must be in accordance with the instructions in the user guidelines. If used in a manner not intended may cause injury.

 This symbol will appear beside possible safety risks.

 This symbol will appear beside helpful information and tips.

## Introduction

### **Intended use of Vertica®**

Vertica® is a battery powered hand-held medical device that makes use of RF energy to improve erectile function. The device is intended for home use.

### **Intended user of Vertica®**

The Vertica® device is intended to be used by adults at home for the purpose of improving erectile function by increasing blood flow into the penis and for increasing cavernosal volume.

## About Erectile Dysfunction (ED)

Erection is a neuro-vascular event. Excited nerves initiate erection by dilating the arteries (used for increasing blood flow into the penis), when the nervous and vascular systems are intact- erection occurs. Any neural or vascular (blood vessels) dysfunction may have a negative impact on normal erectile function.

Powered by patented technology, Vertica® is a non-invasive home-use device for the treatment of **ED** by enhancing blood inflow into the erectile bodies, thereby improving the erection process.

The Vertica® device is the first appliance that targets the blood vessels involved in erectile function, by inducing thermal stimulation which causes even more blood inflow allowing dilatation of the arteries.

The Vertica® technology generates vasodilation using its **RF** energy induced heat in the areas involved in the erectile process.

## Treatment with Vertica®:

- The Vertica® device consists of two parts that accurately provide a deep treatment for erectile dysfunction.
- The erectile tissue which is responsible for erection expands (or stretches) from the visible part of the penis, deep into the pelvis and behind the pubis.
- The **PAD** part of the Vertica® device is designed to treat this area specifically.
- Therefore, the Vertica® method has a high-degree of accuracy – it covers the whole length of the erectile bodies and provides a complete therapeutic solution to the issue.
- The Vertica® device consists of 6 (**RF**) generator electrodes (and one pair of pins) located around the inner circle of the device's ring. The combination of the advanced algorithm controls equal delivery spreads of **RF** energy, with simultaneous real-time regulation of the optimal energy outflow by continuous skin temperature measurement. This process ensures that the user experiences optimal individual results.
- Each treatment is unique due to the use of particular hardware and software technology. The required optimal level of energy on the specific area of treatment is provided during actual real-time use.
- The target tissue is accessed by the **RF** energy which is channeled by the novel positioning mode of the electrodes, resulting in optimal treatment to the selected area.
- During treatment sessions, the device gathers data, learns and retains calculated skin parameters and adapts the device's parameters accordingly.
- Applying ultrasound gel or **RF** conductive gel during treatment ensures the best-possible energy transmission between the electrodes and the target area.

## Package Contents

Your Vertica® package contains the following items:

- Vertica® device
- Electrode **PAD**
- Charger/Adapter
- Ultrasound or **RF** conductive gel\*
- Quick reference guide
- User manual
- Device warranty

\* Vertica® provides ultrasonic/conductive **RF** generic gel with CE certification.

### Safety Features Information

With Vertica®, your safety comes first!

Please read the information provided before use.

The Vertica® device is created with the following safety features:

- **Six Temperature sensors** – the skin surface temperature is continuously monitored and measured by six specifically designed sensors concealed inside the electrodes.
- **Ultrasound gel or RF Conductive gel** – The device will automatically stop delivering energy once it identifies lack of skin contact between the Vertica® electrodes, **RF** conductive gel, and the skin surface of the penis.
- **Power LEDs (1-6) – Six LEDs** are located around the energy button. Each **LED** indicates a power level that lights-up according to the selected power strength that flash during treatment. Whenever **RF** is not delivered, the **LEDs** will stay lit without flashing. The number of **LEDs** always indicates the power level. One **LED** is the minimum level; six **LEDs** is the maximum power level. The device is equipped with an automatic control mechanism to prevent over-heating; the “smart” sensor on the device detects optimal temperature, allowing full regulation of energy transmission.

- Charging - All functionality will stop once the charging cable is connected to the device.
- Penile shaft sensor - The device will automatically deliver RF energy only when the required penile shaft characteristics (impedance values) are correctly measured by the device. Energy is delivered when these measured values match with the device's pre-determined values to allow optimal treatment.
- Automatic power off - The device will automatically shut down after 10 minutes of inactivity.

### **Precaution and safety instructions**

Only use this device for its intended function and as instructed in the user manual.

- Always switch the device off after each treatment session and during cleaning.
- The device must be charged only with the supplied charger. Do not use any other charger!
- Do not use the device if it is damaged.
- Do not operate the device close to any inflammable liquids (i.e. alcohol and acetone).
- Always keep the device out of reach of children.
- Do not attempt to use the device on any other parts of the body other than that permitted in the instructions.

 The device requires the use of either **RF** conductive gel or ultrasound gel. For your safety and in order to achieve effective treatment, a generous layer of gel should be applied along the penis and care should be taken to add gel as needed during the treatment. For illustration, please see Figure 5. Prior to use, check the validity and expiry dates on the label of the **RF** conductive gel.

Once opened, do not use the gel after the 12-month period. If the gel is purchased separately, please ensure that the product meets the regulatory requirements of the local Ministry of Health, and that it is intended for ultrasound or **RF** conduction purposes.

## Contraindications and warnings

**⚠ Do not use the Vertica® device** if you experience any of the following conditions:

- A cardiac pacemaker implant or suffer from any other form of heart condition e.g. Arrhythmia
- Any metallic implanted devices, including body piercings located around the area of treatment.
- Any type of skin damage to the area of intended treatment e.g. lesions
- A blood clot disorder
- Take antiplatelet medication
- Take or have taken in the last 12 months Isotretinoin (Accutane)
- Any Neurostimulator implant

**⚠ Please consult your physician if you have any concerns regarding medications or health conditions not listed above.**

### **⚠ Possible side effects**

Due to the treatment which is heat-based, redness of the skin and minor swelling may occur. \* This is an indication that the proper required heat is applied for the desired outcome to be achieved. However, after treatment the redness of the skin and minor swelling will subside.

Additional side effects may occur such as mild local pain, blistering, stinging, burning, and flaking. These effects can last for several minutes and are expected to ease over time with subsequent treatments. Discontinue the treatment if any of the above-mentioned side effects continue for over **24** hours (Please consult your physician).

Take note that treatment results differ between users due to individual uniqueness which is not manufacturer guaranteed.

If you have any concerns regarding the sensitivity conditions or side effects, please consult your physician.

*\*Energy output will automatically stop once the "smart" sensors detect lack of gel or lack of contact with the penis.*

## **What to Expect After Treatment?**

### **Short-term Effect**

After a session, an overall warm sensation is felt on the treated area. This effect subsequently dissipates.

### **Long-term Effect**

For the desired effective result, twice-weekly treatments are recommended.

## Getting to know Your Vertica® device: Panel interface

**Fig 1:** Led indicators and control buttons

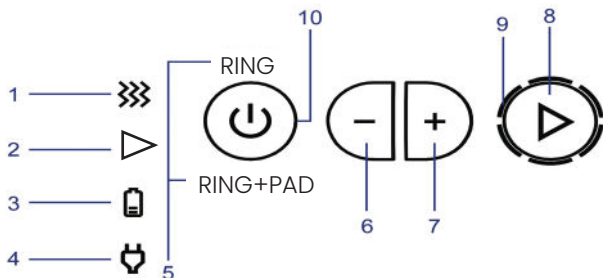

Indicators	Control buttons
<b>1</b> - Energy is delivered, skin parameters are in correct range (Indicated by constant white LED)	<b>6</b> - Decrease energy level
<b>2</b> - Enabling device to power energy out (flashing blue LED)	<b>7</b> - Increase energy level
<b>3</b> - Charging (Orange LED)	<b>8</b> - Energy button
<b>4</b> - Power supply connected (Green LED)	<b>10</b> - Power and Mode button
<b>5</b> - Mode indicator	
<b>9</b> - Power Level indication	

## Control buttons and indicators

**All control buttons and indicators are situated on the right-side handle.**

**See fig 1. There are 2 round buttons, and 2 half-round buttons:**

### 1. The Power switch and indicator

The round button on the left is the power switch:

Press the power button to turn the device “ON”. Power “ON” is indicated by lightening the selected mode (“Ring” or “Ring + Pad”).

**The power switch is also used to select between “Ring mode and “Ring + Pad” mode:**

“Ring” means that only the ring electrodes are “on” (those surrounding the penis) and the pad is “OFF”.

“Ring + Pad” means that, the ring and pad electrodes are both “on”.

**How to select “Ring mode”:** The device will start by default at “Ring mode”. Each press on the power button will alternate between the two modes, “Ring” mode and “Ring + Pad” mode.

To turn OFF the device, press and hold the power button for **3** seconds.

### 2. Energy button & Power level indication

This button is the round button on the right:

Press and hold the Energy button to enable energy output; The **LEDs** will steadily remain lit when the device is “On” and the energy button it is not pressed.

Important: It is possible to lock this function by a double click. This feature is enabled only after 3 seconds of single pressing. (Indicated by Constant Blue LED). Press any button on the device to cancel lock.

The power level **LED** lights indicate the power level output. The **LEDs** will flash when the energy button is pressed. Ranges from **1-6** (low to high).

1. The first minimum power level is indicated by a single white **LED** light.
2. The second power level is indicated by two white **LED** lights.
3. The third power level is indicated by three white **LED** lights.

4. The fourth power level is indicated by four white **LED** lights.
5. The fifth power level is indicated by five white **LED** lights.
6. The sixth power level is the maximum and is indicated by six white **LED** lights.

### 3. Plus and Minus buttons (+/-)

They are half-round buttons located between the 2 rounded buttons (power switch and energy buttons):

Press the plus (+) button to increase the energy output. The power level will increase, as indicated by the LED light circling the energy button on the right. Press the minus (-) button to decrease the energy level indicated by one less LED light circling the energy button on the right.

### 4. Charging LED indicator

During charging, the Orange indicator will turn on. When the device is fully charged, the indicator will turn OFF. If the indicator flashes, this means that there is a fault with the Battery or charger. If this happens, please disconnect the charger from the power outlet and the device.

Wait for a minute before re-connecting to the charger and power outlet. If the Orange light continues to flash contact customer support.

The device will not permit treatment when the battery needs to be charged. In this case, the device will not operate.

The magnetic charger must be attached to the charging connector situated on the left side of the control panel handle (**See fig.2**). Only then connect the cable to the electrical outlet

Fig 2

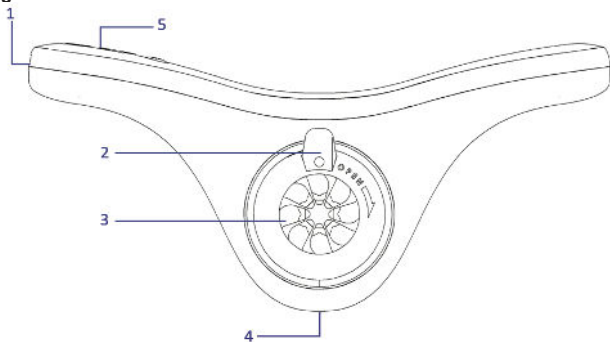

1. Power supply connector
2. Release handle
3. Electrodes
4. Pad connector
5. User interface

### 5. Energy output electrodes

All electrodes must be in full contact with the skin area during treatment. Press the energy button to allow energy release. The **LED**  flashing lights indicate energy output is active from the electrode tips.

### 6. Applying the PAD

It is recommended to shave the perineal area before applying the **PAD** (the area between the anus and scrotum). We recommend applying the **PAD** before inserting the penis into the ring.

**Step 1:** Connect the pad extension to the device at the designated connector (**fig 3**).

**Step 2:** Place the electrode of the pad (**fig 3a**) to your skin at the perineum area (**fig 3b**) always maintain contact between the electrodes and your skin. The **PAD** will activate only when the “Ring & Pad” mode is on.

**Fig 3**



**Fig 3a**

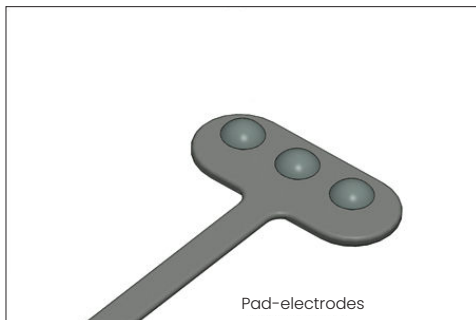

**Fig 3b**

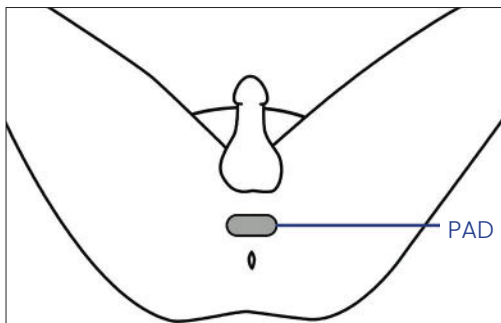

#### **6. Penis insertion side**

Open the ring with the “release” handle and insert penis, (**fig 4**). Insert the penis from the back end through to the front end of the device, as indicated in **fig 4a**.

**Fig 4**

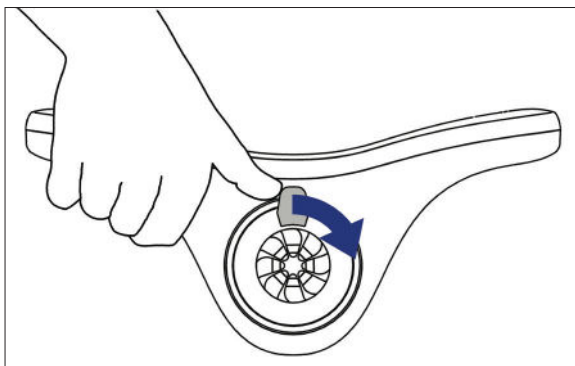

Fig 4a















### 7. RF energy

The white indicator (⏏) means energy delivery is "ON". The light will switch "ON" most of the time. When the heat exceeds the preset temperature threshold, it turns off indicating the energy delivery has stopped until it returns to the pre-set temperature limits.

Both "Ring" and "Ring & Pad" modes should work for a total of **15** minutes for each mode. After performing the process of 15 minutes of Energy delivery (indicated by White LED), the device will indicate that the session has ended with 3 consecutive vibrations. Total time of treatment will depend on individual skin characteristics.

## Indicator summary

State	Indication light		Activity Indication
Device <b>ON</b>	Power switch indicator		The Vertica® device is on and ready
<b>RF active ON</b>	White light <b>ON</b>		Skin parameter at correct range
Energy active	Flashing blue <b>Led</b>		<b>RF energy active</b>
Charger connected	External power indicator <b>ON</b>		Vertica® connected to external power
Charging	Charging indicator <b>ON</b>		Device is connected and actively charging
Battery fully charged	Charging indicator <b>OFF</b> External power indicator <b>ON</b>		Battery is fully charged and still connected to power supply
Energy level <b>Connected to the selected mode</b>	Six <b>Leds</b> around trigger button		One <b>LED</b> light indicates power level <b>1</b> (minimum)
			Two <b>LED</b> lights indicate power level <b>2</b>
			Three <b>LED</b> lights indicate power level <b>3</b>
			Four <b>LED</b> lights indicate power level <b>4</b>
			Five <b>LED</b> lights indicate power level <b>5</b>
			Six <b>LED</b> lights indicate power level <b>6</b> (maximum)

## Let's get started!

### Treatment procedure:

Start treatment in a seated position making sure the electrodes of the pad are in contact with the perineum area. In the first stage the treatment is only "Ring mode", and in the second stage you move to the "Ring+Pad" mode.

It is recommended to shave the perineum area to ensure optimal contact.

Check that the device is fully charged before treatment. The battery **LED** indicator on the right means that the device is ready for use.

1. Press the power button (⏻) to switch the device on. By default, the device is now in standby mode – both energy level and power indicator show that the device is "ON" at the minimum power level and in "Ring" mode.
2. Stay on "Ring" mode (default) or switch to "Ring + Pad" mode by pressing the power button.
3. To Select the desired level of power, press the plus or minus ("+" or "-") button to increase or decrease the energy output level. **It is recommended that you start the first treatment at level 1 and increase according to the sensation of heat you desire.** You are able to increase or decrease the energy level during the treatment. Choose the maximum heating level that you feel comfortable with during treatment.
4. Apply ultrasound/**RF** conductive gel along the penis to fully cover the surface. In order to achieve optimal treatment, a generous layer of gel should be applied. Make sure that the gel layer covers about 3-5 mm of the electrode dome as shown in the Figure 5. Add gel as needed during treatment.

**Fig 5**

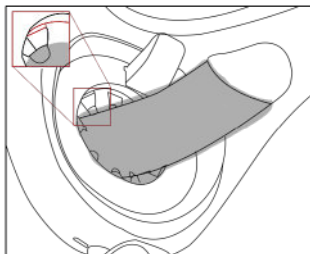

5. Open the ring using the specified "Release" handle situated at the front part of the device above the ring (**fig 4**), then insert the penis through the ring and slide the device to the base of the penis (close to the body as much as possible). In this position, the backside of the device should make contact with your pelvic area (**fig 4a**). Shift the "release" handle back to let the ring fit comfortably and snug inside (**fig 4a**). Check the power indicators around the energy button to verify that the device is properly set to the desired energy output level. (We recommend starting at level 1 – minimum energy output level, **1 LED** lit; level 6 – maximum energy output level, **6 LEDs** lit).
6. Start the treatment by constantly pressing the energy button. Then the device will start the energy output. Releasing the energy button stops the energy output immediately.
7. It is recommended that you slide the device forward about 1 cm (up to the penis dome) every half-minute or when the white **LED** light is turned **OFF** for at less 3 seconds (**RF** is **OFF**).
8. When there is no more space to slide the device forward, stop the energy output by releasing the energy button and slide the device back to the base of the penis, (**as in par. 5**) and repeat the process. Always advance forward and not backward when the energy button is released.
9. For the desired results, all electrodes must be in contact with the penile skin throughout the whole treatment period. There should be always enough gel during the treatment. It is not unusual to feel a warm sensation on the skin during the session, which could indicate the need to add more gel.
10. Regulate temperature sensation by adjusting the control buttons ("+" or "-") during treatment.
11. The energy output level of the device can be controlled before and during treatment. The heat level will increase or decrease by simply adjusting the ("+" or "-") buttons accordingly, indicated by the LED light levels (1-6).

- We recommend 15 minutes session for "Ring" mode and another **15** minutes for "Ring + PAD" mode. Repeat the treatment again for no less than **15** minutes according to the instructions in par. 3, with the PAD accessory connected and the Pad + Ring mode is on. Be sure to move the device forward by about 1 cm every 30 seconds - or whenever the white LED light is off, for at least 3 seconds.
  - Switch the device off before you clean the electrode surface area. At the end of the treatment, it is necessary to clean the Pad accessory and the ring area in the device with regular running water. Check to make sure that no gel residue is present. Dry the device with a clean dry cloth.
  - After each treatment session, clean the device and charge it for a period of at least 5 hours.
- i** If you do not experience any heat during treatment, please contact our customer service at +972-53-366-0396.
- i** Please report to the customer service any serious incident, if such accrues. If a serious incident occurs, you may report it to the regulatory authorities of your country.

### Recommended treatment

It is recommended to perform the full treatment plan of **three** sessions per week for a period of one month.

Follow-up treatment: At least twice a week after the first month.



### Recommended care:

Scan the QR-code to view Vertica® cleaning procedure >



### Cleaning the device and electrodes after use

Before cleaning, make sure the Vertica® device power is **OFF** and is disconnected from the charger.

- The electrode-ring that has made contact with the skin and the gel should be rinsed after every use.
- The Vertica® device is water-resistant and can be easily rinsed under running tap water on the area of the electrodes.
- The Vertica® device and the pad accessory should be rinsed only with water. No other detergents, soap or alcohol etc. should be used.

- Clean first with a water-based wet wipe and if a more thorough cleaning is needed, rinse it with running tap water after every use.
- You may also clean the Vertica® device with a clean moist cloth.

**Do not immerse the Vertica® device in water!**

Be careful not to rinse with **hot** water to avoid burning your hands.

- The Vertica® device can be wiped using a soft dry cloth and left to dry after rinsing.

### Storage instructions/conditions

The Vertica® device should be stored in room temperature.

- Store the Vertica® device in the box supplied upon purchase.
- Keep the device and charger away from dampness, or debris that may settle between the electrodes or the charger.
- Keep away from reach of children

<b>Environmental conditions for transport and storage between uses</b>	
Temperature (°C)	-25°C - +60°C
Relative Humidity (%)	max 95% at 40°C
Atmospheric Pressure (hPa)	max 1100
<b>Environmental operating conditions</b>	
Temperature (°C)	15°C - 30°C,
Relative Humidity (%)	max 60%
Atmospheric Pressure (hPa)	max 1100

## **7** Troubleshooting (FAQ)





Use the following information to help solve any difficulty you may experience with your Vertica® device.











<b>Problem</b>	<b>Likely cause</b>	<b>Solution</b>
Device will not power <b>ON</b>	Battery power empty	Charge the device
Indicator light "ON" with no heat sensation	User's skin not recognized by device. Insufficient gel on the treated area	Apply sufficient gel on the treated area.
Area of treatment not warm	<ul style="list-style-type: none"> <li>• Insufficient gel on treatment area</li> <li>• The electrodes are not in contact with the skin</li> <li>• Your power level is on minimum (one white LED lit).</li> </ul>	<ul style="list-style-type: none"> <li>• Apply additional gel to the area.</li> <li>• Assure that all electrodes are in contact with the skin.</li> <li>• Press "+" button to increase energy.</li> </ul>
Battery indicator fails to function during charging.	Device not connected properly or not receiving electricity	Check the electricity connections. Contact customer support.
Side effects	Sensitive to heat treatment or to the used gel.	Contact our customer support and consult with your doctor.
Heat sensation to testicles by the pad	Improper placement of the pad.	Place pad strictly according to instructions

## Label Material Specifications

Specifications	Vertica® device
Electrical power consumption	12 watts
Input voltage	100 VAC – 240VAC 50-60Hz 100Vac 0.5amps
Output voltage	15 vdc
Current output	0.8A
Dimensions	340x250x55mm
Weight	170g

Specifications	Vertica® device performance
RE output frequency	1 MHz
Electrode maximum temperature	42±1°C
Maximum treatment time per mode	15 min of energy delivery (white light)

Symbol	Explanation
	Refer to manual
	Type <b>BF</b> applied part
	Fragile; handle with care
	Double insulated appliance-class2
	Temperature limitation

	Humidity limitation
	Atmospheric pressure limitation
	Protected against solid foreign objects of 12.5 mm (0.5 in) diameter and greater; Protected against vertically falling water drops when enclosure tilted up to 15°.
	<p>Means that this product is not to be disposed of with any other household materials in the E.U. Recycle and promote the reuse of sustainable resources in order to avoid possible harm to human health and the environment from uncontrolled waste materials.</p> <p>Please use our return and collect service for used devices or simply contact the place of purchase where they will be happy to receive the device for safe environmental recycling.</p>
	Indicates the medical device manufacture
	Authorized representative
	Date of manufacture
	Serial number
	Lot number
	Medical device
	CE marking

## Care, Maintenance and Storage

 **WARNING:** This electrical device uses radio frequency wavelengths!

The following cautions should be carefully read.

- Do not attempt to open, break or repair the Vertica® device case in any way.
- Always store the device in its original box in a dry and safe place, away from the reach of children, direct sun-light and heat.
- Disposal of the Vertica® device must be in accordance with EC regulations and country of purchase.

 For more information on how to safely dispose of your device, please contact customer service or otherwise visit your local recycling center.

## Assembly and Maintenance

The Vertica® device is fully factory assembled.

Ensure to clean the electrodes area after each treatment and store as instructed in the manual.

## Travel

If you travel with your Vertica® device, pack the device, charger and gel in its original packaging to prevent damage.

## Gel

Routine use of the Vertica® device requires application of the gel that is supplied with the Vertica® device. If needed, you can use, or purchase any water-based ultrasound conductive gel separately. Please note that only gel intended for ultrasound or conduction of RF should be purchased, and that it meets all the regulatory requirements of the local Ministry of Health.

The ultrasound/RF gel can be purchased on Vertica website.

## Disposal of the Vertica® device

The device contains a rechargeable battery (Lithium-Ion (Li-Ion)). Like other batteries of this type, if burned or punctured, it could release toxic material which could cause injury.

The device has no replaceable internal power source (batteries are not replaceable).

If you wish to dispose of the device, do not disassemble components. Discard device entirely. Check with local solid waste officials for details concerning recycling options and proper disposal. In the United States, call toll free 1-800-8-BATTERY-visit the Battery Recycling Corporation website at <http://www.call2recycle.org/>

The life of Li-Ion batteries is strongly influenced by their care. If properly maintained, the battery is capable of more than 300 charge/discharge cycles before dropping to 80% of capacity. Do not exceed the allowable ambient temperatures during charging, operating, or storage.

 **WARNING:** No modification of this equipment is allowed. Do not modify this equipment without authorization from the manufacturer. If this equipment is modified, appropriate inspection and testing must be conducted to ensure continued safe use of the equipment.

**Declaration – electromagnetic emissions**

Emissions test	Compliance	Electromagnetic environment – guidance
RF emissions CISPR 11	Group 1 Class A	The <b>Vertica®</b> uses RF energy only for its internal function. Therefore, its RF emissions are very low and are not likely to cause any interference in nearby electronic equipment.
Harmonic emissions IEC 61000-3-2	Class A	The <b>Vertica®</b> is suitable for use in all establishments other than domestic and may be used in domestic establishments and those directly connected to the public low-voltage power supply network that supplies buildings used for domestic purposes, provided the following warning is heeded: This equipment/ system may cause radio interference or may disrupt the operation of nearby equipment. It may be necessary to take mitigation measures, such as re-orienting or relocating the Vertica® or shielding the location.
Voltage Fluctuations and Flicker IEC 61000-3-3:2013	Complies	

**Declaration – electromagnetic immunity**

<b>IMMUNITY test</b>	<b>IEC 60601 test level</b>	<b>Compliance level</b>	<b>Electromagnetic environment –guidance</b>
Electrostatic discharge (ESD) IEC 61000-4-2	8 kV contact 2, 4, 8, 15kV air	8 kV contact 2, 4, 8, 15kV air	Floors should be wood, concrete or ceramic tile. If floors are covered with synthetic material, the relative humidity should be at least 30 %.
Electrical fast transient/burst IEC 61000-4-4	2 kV for power supply lines 1 kV for input/output lines	2 kV for power supply lines N/A	Mains power quality should be that of a typical commercial or hospital environment.
Surge IEC 61000-4-5	1 kV line(s) to line(s) 2 kV line(s) to earth 2 kV Signal input/output) to earth	1 kV line(s) to line(s) 2 kV line(s) to earth N/A	Mains power quality should be that of a typical commercial or hospital environment.
Voltage dips, short interruptions and voltage variations on power supply input lines IEC 61000-4-11	0% UT; 0.5cycle at 0°, 45°, 90°, 135°,180°, 225°, 270° and 315° 0% UT; 1cycle and 70% UT; 25/30 cycles Single phase at 0° 0% UT; 250/300 cycle	0% UT; 0.5cycle at 0°, 45°, 90°, 135°,180°, 225°, 270° and 315° 0% UT; 1cycle and 70% UT; 25/30 cycles Single phase at 0° 0% UT; 250/300 cycle	Mains power quality should be that of a typical commercial or hospital environment. If the user of the <b>Vertica®</b> requires continued operation during power mains interruptions, it is recommended that the Vertica® be powered from an uninterruptible power supply or a battery.
Power frequency (50/60 Hz) magnetic field IEC 61000-4-8	30 (A/m)	30 (A/m)	Power frequency magnetic fields should be at levels characteristic of a typical location in a typical commercial or hospital environment.

**Declaration – electromagnetic immunity**

<b>IMMUNITY test</b>	<b>IEC 60601 TEST LEVEL</b>	<b>Compliance level</b>	<b>Electromagnetic environment – guidance</b>
Conducted RF IEC 61000-4-6 Radiated RF IEC 61000-4-3	3V, 6V 3V/m 3V from 0.15 to 80MHz; 6V from 0.15 to 80MHz and 80% AM at 1kHz 3V/m from 80MHz to 2.7GHz	3Vrms, 6V 3V/m 3V from 0.15 to 80MHz; 6V from 0.15 to 80MHz and 80% AM at 1kHz 3V/m from 80MHz to 2.7GHz	<p>Portable and mobile RF communications equipment should be used no closer to any part of the Vertica®, including cables, other than the recommended separation distance calculated from the equation applicable to the frequency of the transmitter.</p> <p>Recommended separation</p> $d = \left[ \frac{3,5}{V_1} \right] \sqrt{P}$ $d = \left[ \frac{12}{V_2} \right] \sqrt{P}$ $d = \left[ \frac{12}{E_1} \right] \sqrt{P} \quad 80 \text{ MHz to } 800 \text{ MHz}$ $d = \left[ \frac{23}{E_1} \right] \sqrt{P} \quad 800 \text{ MHz to } 2,5 \text{ GHz}$ <p>Where P is the maximum output power rating of the transmitter in watts (W) according to the transmitter manufacturer and d is the recommended separation distance in meters (m).</p> <p>Field strengths from fixed RF transmitters, as determined by an electromagnetic site survey, should be less than the compliance level in each frequency range.</p> <p>D Interference may occur in the vicinity of equipment marked with the following symbol:</p> 

## Test specifications for ENCLOSURE PORT IMMUNITY to RF wireless communications equipment

Test frequency (MHz)	Band <sup>a)</sup> (MHz)	Service <sup>a)</sup>	Modulation <sup>b)</sup>	Maximum power (W)	Distance (m)	IMMUNITY TEST LEVEL (V/m)	Compliance level (V/m)
385	380 – 390	TETRA 400	Pulse modulation <sup>b)</sup> 18 Hz	1.8	0.3	27	27
450	430 – 470	GMRS 460, FRS 460	FM <sup>c)</sup> ± 5 kHz deviation 1 kHz sine	2	0.3	28	28
710	704 – 787	LTE Band 13, 17	Pulse modulation <sup>b)</sup> 217 Hz	0.2	0.3	9	9
745							
780							
810	800 – 960	GSM 800/900, TETRA 800, iDEN 820, CDMA 850, LTE Band 5	Pulse modulation <sup>b)</sup> 18 Hz	2	0.3	28	28
870							
930							
1720	1700 – 1990	GSM 1800; CDMA 1900; GSM 1900; DECT; LTE Band 1, 3, 4, 25; UMTS	Pulse modulation <sup>b)</sup> 217 Hz	2	0.3	28	28
1845							
1970							
2450	2400 – 2570	Bluetooth, WLAN, 802.11 b/g/n, RFID 2450, LTE Band 7	Pulse modulation <sup>b)</sup> 217 Hz	2	0.3	28	28
5240	5100 – 5800	WLAN 802.11 a/n	Pulse modulation <sup>b)</sup> 217 Hz	0.2	0.3	9	9
5500							
5785							

## Vertica® Warranty

This product holds a warranty for twelve months by Ohh-Med Medical® Ltd., active from the date of purchase.

The warranty covers manufacturing defects of materials and workmanship.

The warranty of this product only remains valid if the instructions in the manual provided are followed.

The warranty shall become null and void if the product is in any way damaged by misuse; accident; unauthorized alteration to the product; attachment of any accessory not stipulated in the manual; and any other conditions that are beyond the control of Ohh-Med Medical® Ltd.

The Company shall not be held responsible for damage to the device caused by incidental or consequential circumstances.

The product will not be covered by warranty under the following circumstances:

1. The product is found to have a defect or damage after the period of warranty has expired.
2. Damage to the product is reported after the validity date of the warranty is expired.
3. The product was not safely stored, operated or used as clearly instructed in the user manual with emphasis on maintenance and cleaning instructions for the device.
4. Any work carried out on the device either by the owner or by a third party invalidates the warranty
5. Any damage to the device caused by natural occurrences such as lightning, floods, earthquakes or any other similar disaster, cancels the warranty cover.

**Guaranteed service under warranty is available by returning the product postage-paid to Ohh-Med Medical® Ltd. customer service center to the address details found on the back cover of this manual.**

**This warranty is only valid with a purchase receipt and after registration on our website - [vertica-labs.com](http://vertica-labs.com).**

Once received, the product repair or replacement service warranty is at the sole discretion of Ohh-Med Medical® Ltd.

The product will receive the guaranteed service as stipulated in the warranty if found to fulfill all necessary requirements and duly returned to the customer.

The customer takes full responsibility for the shipping costs, safety, loss and or damage to the device during shipping.

Regardless of the current warranty period, the replaced or repaired product will require an additional 3-month warranty.

The warranty of the product is guaranteed solely at the discretion of Ohh-Med Medical® customer service center.

Any service carried out by non-authorized persons other than Ohh-Med Medical® customer service will result in the invalidation of the warranty.

### **Limitation of Liability**

In no event shall the Company be individually liable to the Buyer for any damages for breach of fiduciary duty by parties, unless the Company's act or failure to act involves intentional misconduct, fraud, or knowing violation of the law.

Ohh-Med Medical's liability shall not exceed the actual cost of the product as a consequence of manufacturing, sale or supply of the product and its use.

## **Customer Service**

Tel: +972-53-366-0396

Email: [support@vertica-labs.com](mailto:support@vertica-labs.com)

## **Ohh-Med Medical® Ltd.**

Tsivonit St. 1, P.O. Box 89 Tiberias 1410002, Israel

Tel: +972-53-366-0396

E-mail: [info@vertica-labs.com](mailto:info@vertica-labs.com)

Web site: [www.vertica-labs.com](http://www.vertica-labs.com)

Copyright © 2021 Ohh-Med Medical® Ltd.

Vertica® is a trademark of Ohh-Med Medical® Ltd.

All rights reserved. Patented technology.

FOR MORE INFORMATION SCAN THE QR CODE



Issue Date: Feb 2022 | OH\_Misc0008\_Rev C